

Knurled long locking screw M2,6

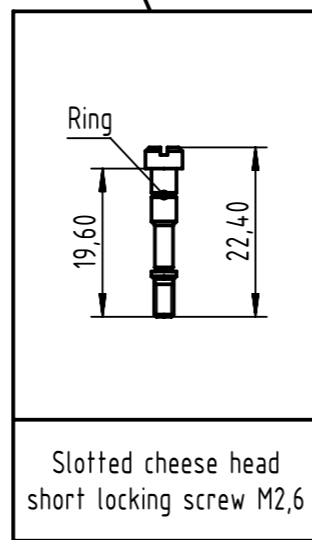

Slotted cheese head short locking screw M2,6

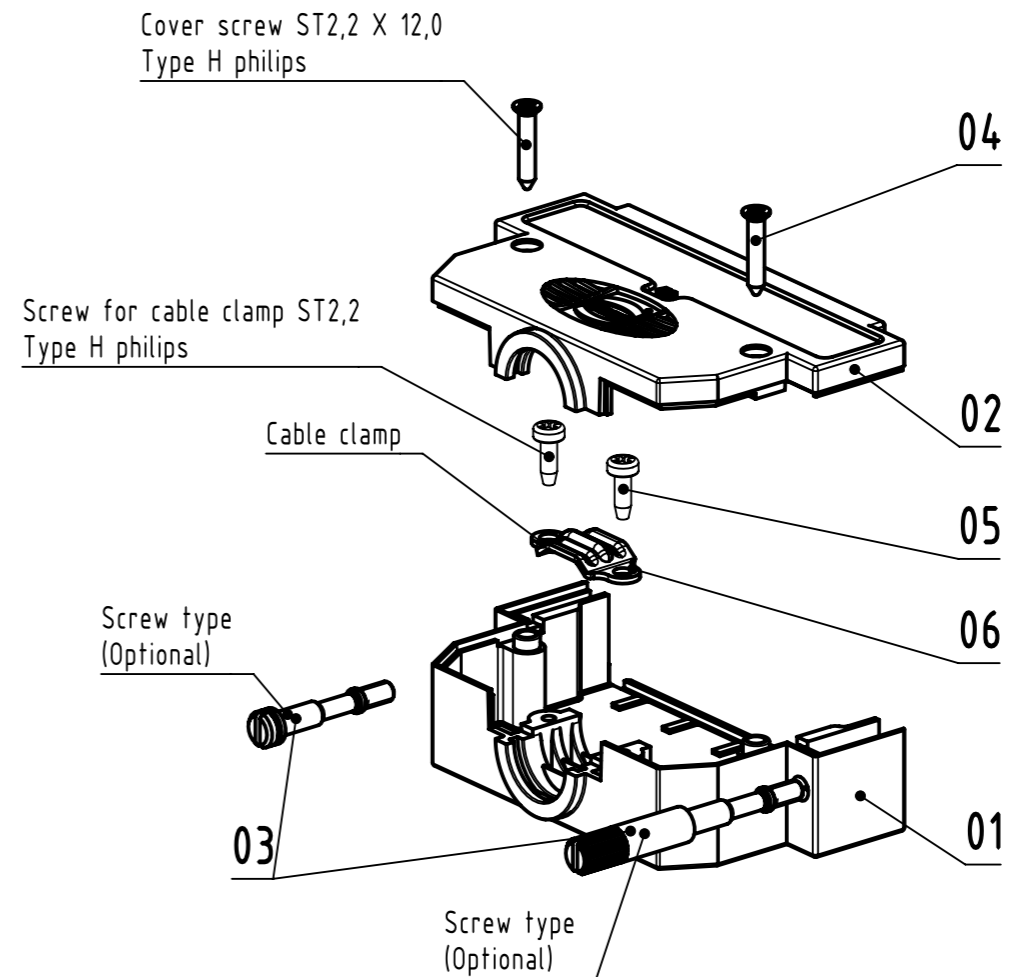

Content D-Sub hood			Spare parts (MOQ100)	
Pos.	Quantity	Description	Part Number	Quantity
01	1	Bottom hood		
02	1	Top cover		
03	2	Locking screw:(Preassembled)		
		either slotted cheese head short locking screw M2,6(for 0967 050 0484)		
		or knurled long locking screw M2,6(for 0967 050 0494)		
04	2	Cover screw ST2,2		
05	2	Clamp screw ST2,2	0967 000 9945	1
06	1	Cable clamp	0967 000 9943	1

09 67 050 04X4			
09 67 050 0494	M2,6	Long locking screw	With ring
09 67 050 0484	M2,6	Short locking screw	With ring
Part number	Screw size	Screw type	Identification for locking screw

All rights reserved
 Department EL PD
 HARTING
 D-32339 Espelkamp

All Dimensions in mm
 Original Size DIN A3
 Scale 1:1
 Free size tol.
 Created by ZENGDO
 Inspected by LUOK
 Standardisation ROEBEN
 Date 2022-01-21
 State Final Release

Title: D-Sub metallized hood 50-pole with locking screws
 Type TB
 Number 096705004X4
 Ref. Sub.
 Doc-Key / ECM-Nr. 100847211/UGD/002/B 50000208988
 Rev. B
 Page 1/1